



Faculty of Forestry, Zagreb University

Department for Furniture and Wood Products LABORATORY FOR WOOD IN CONSTRUCTION



Durability is in details – example of a recently installed timber cladding in Zagreb

Assist Prof VJEKOSLAV ŽIVKOVIĆ

Prof Dr HRVOJE TURKULIN

Madrid, Spain

24th – 25th February 2016



Instituto Nacional de Investigación
y Tecnología Agraria y Alimentaria

A technical workshop
“Designing with bio-based building materials –
Challenges and opportunities”







TU München Institut für Entwerfen und Bautechnik EBB HOLZBAU
Fachgebiet Holzbau Univ. Prof. Hermann Kaufmann

Aussenwandbekleidungen
Begriffe

D 02_Bauteile
Wand

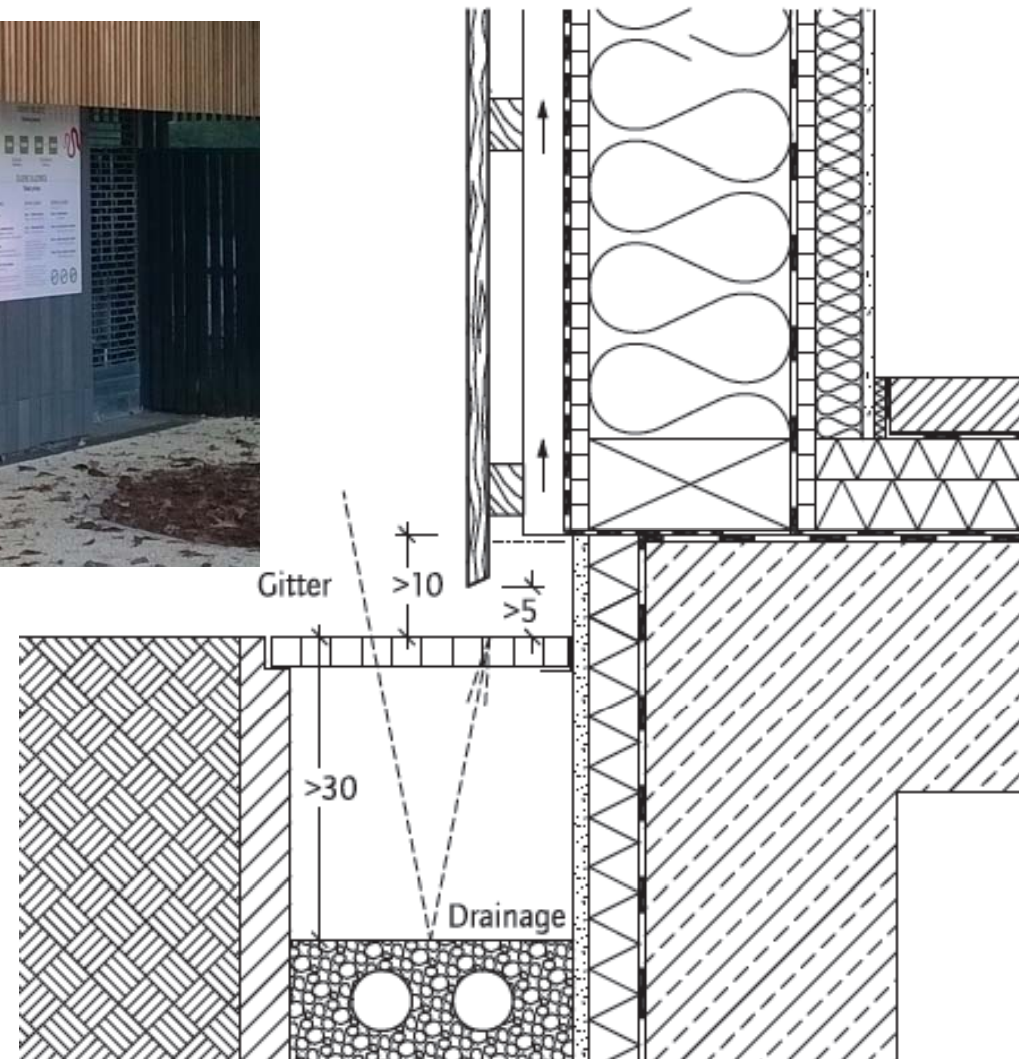
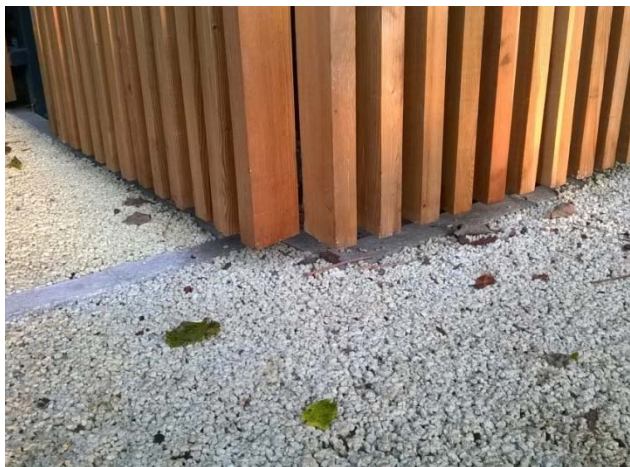

Autoren:
 Klaus Peter Schober,
 Gerhard Grill,
 Claudia Koch
 (alle Holzforschung Austria), A-Wien

Im Blickpunkt: Fassaden

- 12 -

HOLZBAU 6/2010

Altbewährt und topmodern – Fassaden aus Holz
 Wichtige Aspekte beim Einsatz von Holz in der Fassade

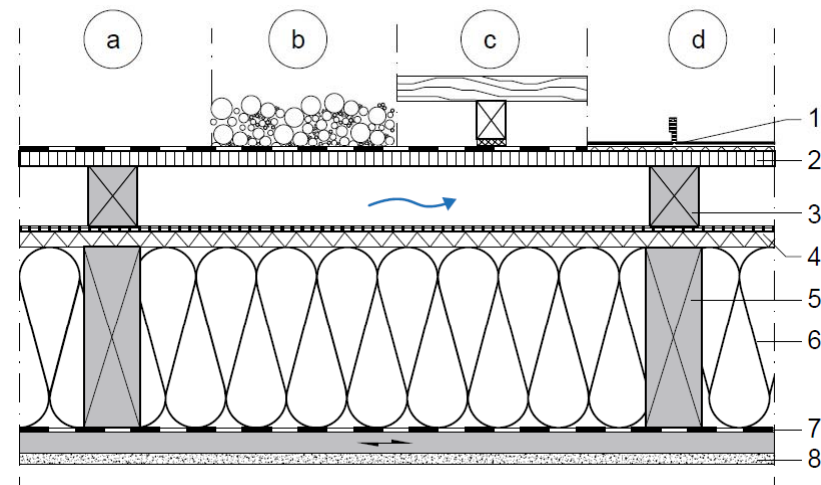
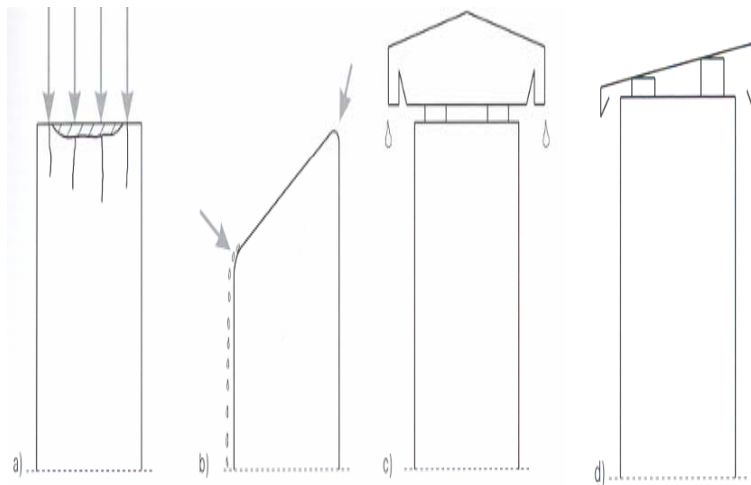
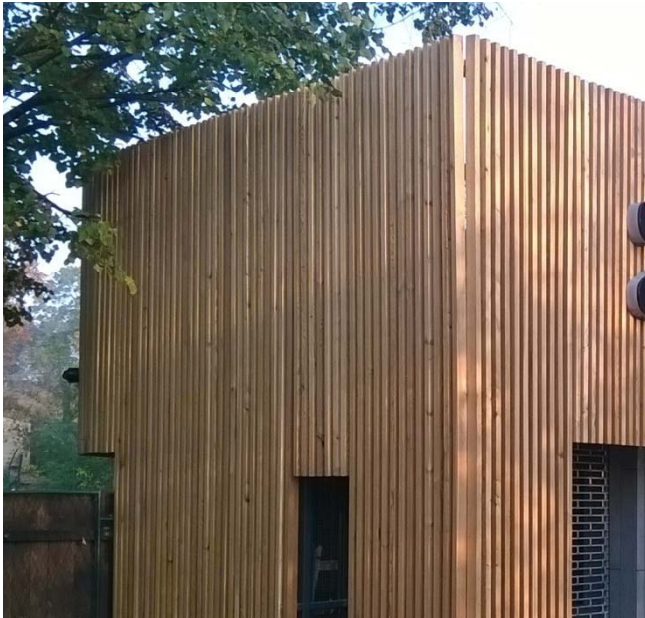

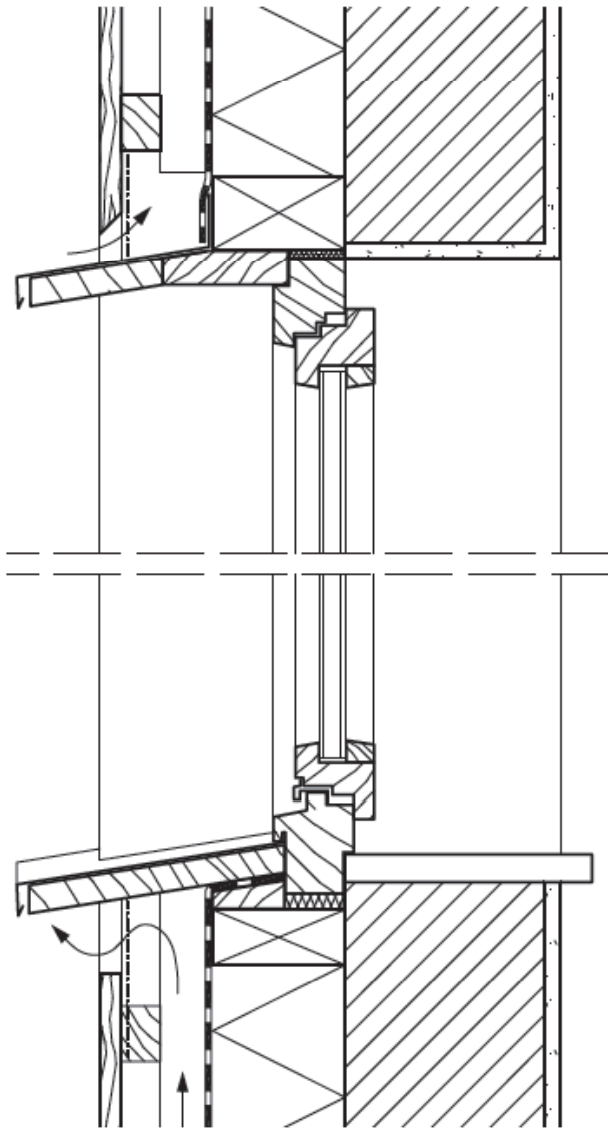

Surface appearance / durability

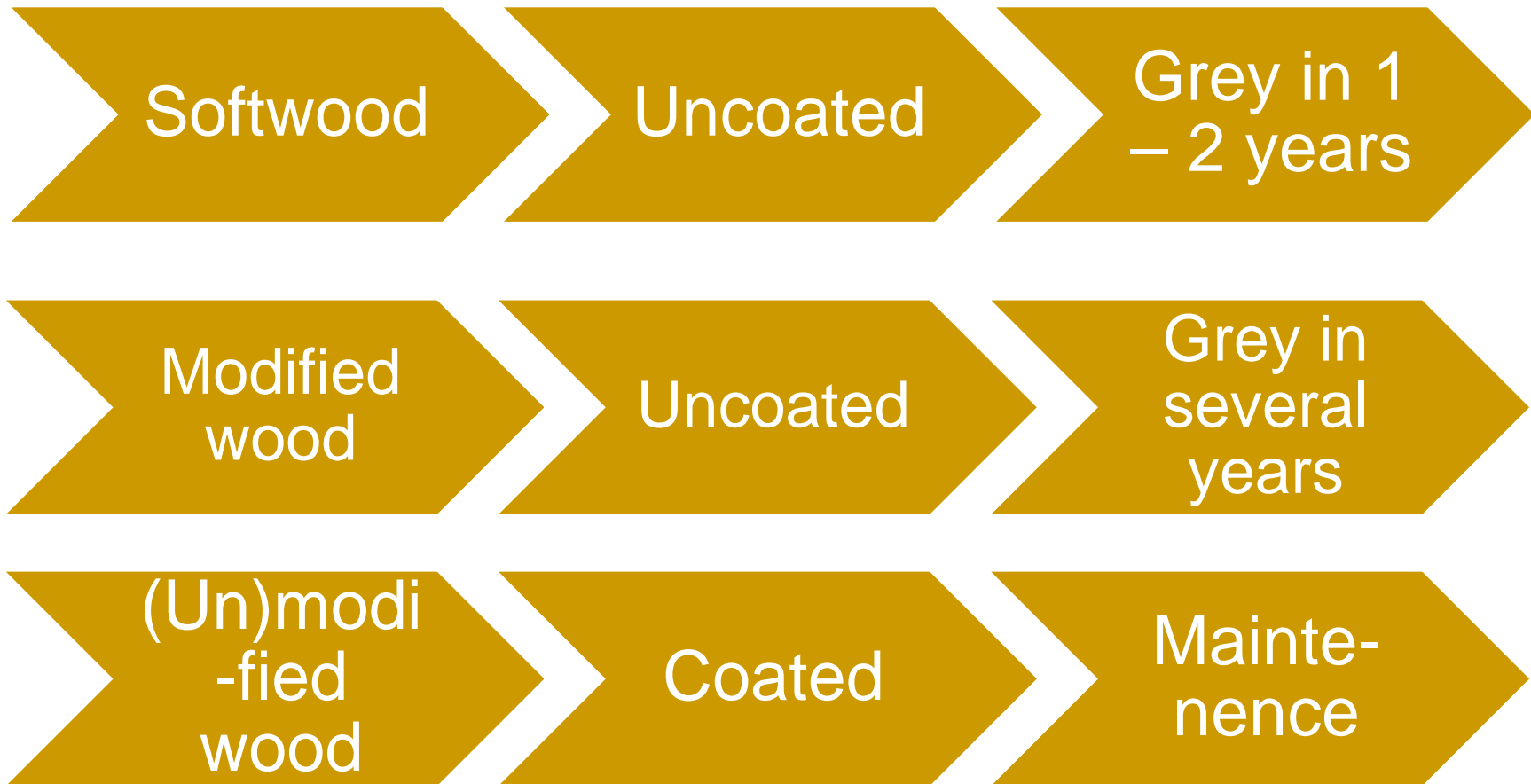

Thank you!



UNIVERSITY OF ZAGREB
FACULTY OF FORESTRY
CROATIA



27th International Conference on Wood Science and Technology - Ambienta 2016
“IMPLEMENTATION OF WOOD SCIENCE IN WOODWORKING SECTOR”
October 13th - 14th 2016

Conference topics should be related, but not limited to the following

- Properties of wood and wood based materials
- Wood processing technology
- Wood products, furniture and interior design
- Wood industry management
- Renewable energy from wooden biomass

Important dates

April 1st, 2016 – deadline for application and abstract submission

April 15th, 2016 – notification of acceptance of the abstract

June 10th, 2016 – deadline for submission of full papers